



Welcome!

Future Factory - Changing your perspective

Creativity Sprint

IVAC Festival, 31st August 2021

Who are we? Official 'Spiel' - Our mug shots



GEORG-AUGUST-UNIVERSITÄT
GÖTTINGEN



STIFTERVERBAND

SPRIN-D



Ostfalia
Hochschule für angewandte
Wissenschaften

New World Travel
The America Specialists

Hurrah...it's post-it time!



Why are you here &
What does creativity mean
to you?

Go to: <https://bit.ly/3gP1lt0>



Why does creative thinking matter?

Education system slowly responding to change

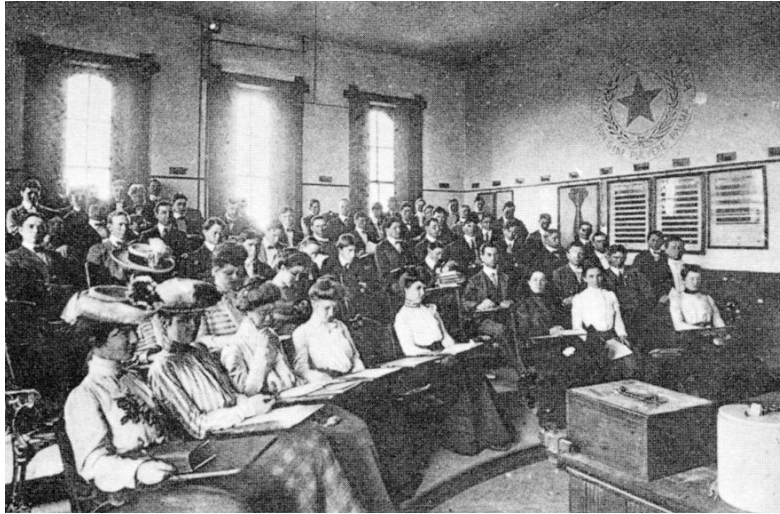

Spot the difference?

Receive content - Study the experience of others



Why care?

The world of work is changing



“...students currently in the education system will have held an average of 10-12 jobs by the time they reach the age of 38.”

“Over 60 per cent children today will work in jobs that currently don't exist.”

World Economic Forum: Education & training require new approaches (March 2016)

Exhibit 1: Students require 16 skills for the 21st century

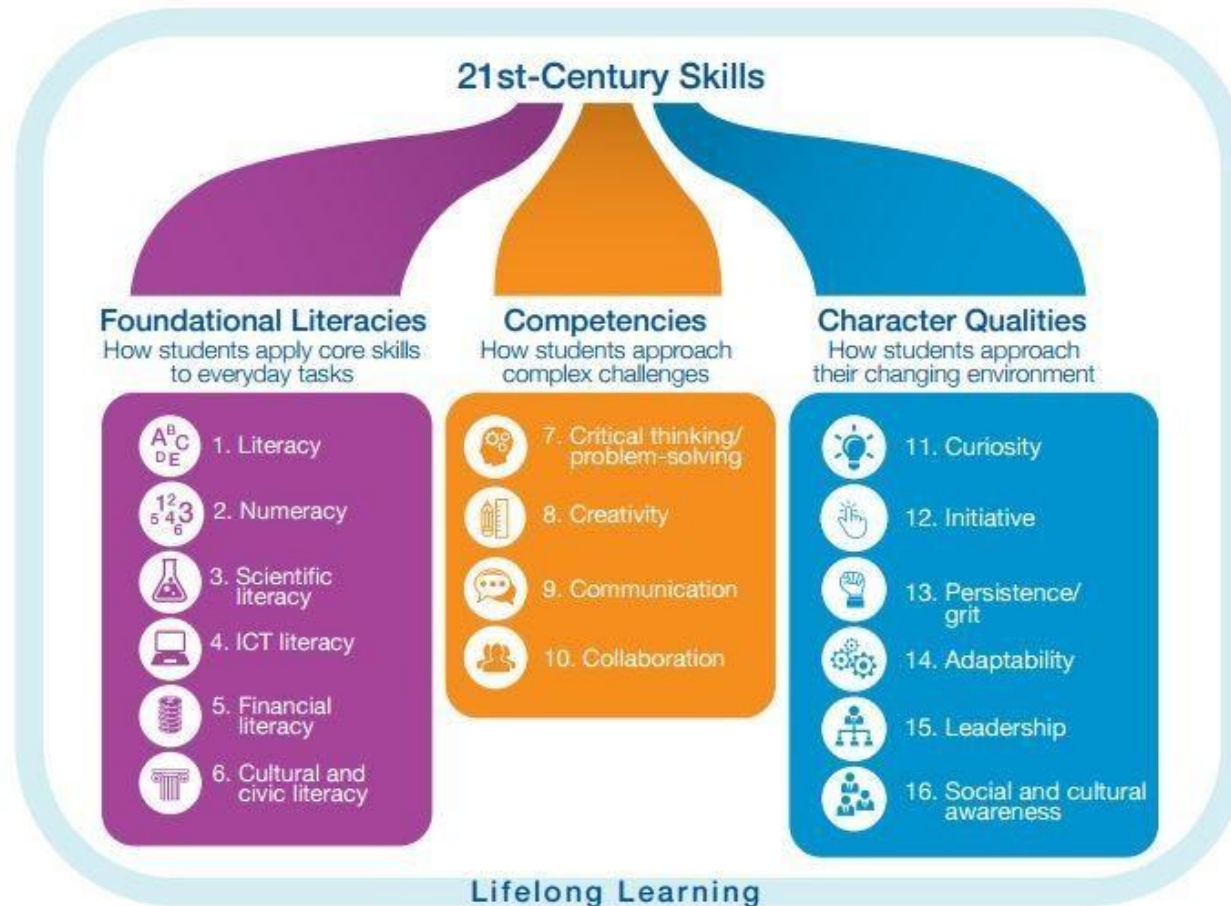

Note: ICT stands for information and communications technology.

“The gap between the skills people learn and the skills people need is becoming more obvious, as traditional learning falls short of equipping students with the knowledge they need to thrive...”

Why skills - not degrees - will shape the future of work



Skills - not educational qualifications - are becoming more valuable to employers Image: Skeeze at Pixabay

Top 10 Skills - WEF 2018 'Future of Jobs' Report

2020:

- 1) Complex problem solving
- 2) Critical thinking
- 3) Creativity
- 4) People management
- 5) Coordinating with others
- 6) Emotional intelligence
- 7) Judgement & decision making
- 8) Service orientation
- 9) Negotiation
- 10) Cognitive flexibility

2015:

- 1) Complex problem solving
- 2) Coordinating with others
- 3) People management
- 4) Critical thinking
- 5) Negotiation
- 6) Quality control
- 7) Service orientation
- 8) Judgement & decision making
- 9) Active listening
- 10) Creativity

CREATIVE

CONFIDENCE



Let's try a bit of creative thinking...





‘A creative adult is a child who has survived’

Ursula K. Le Guin

Getting out of your comfort zone

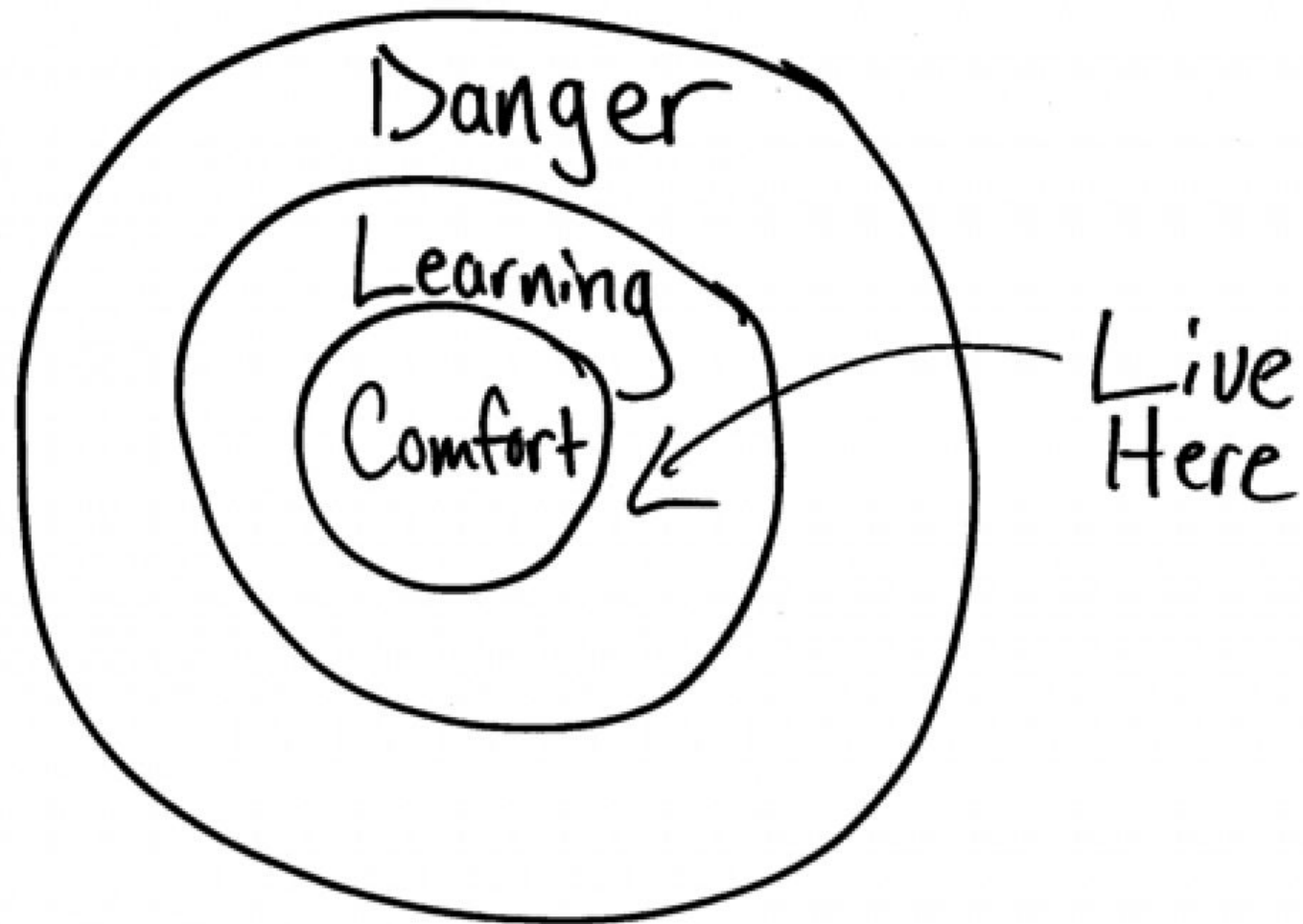

Get into groups



100 uses for...

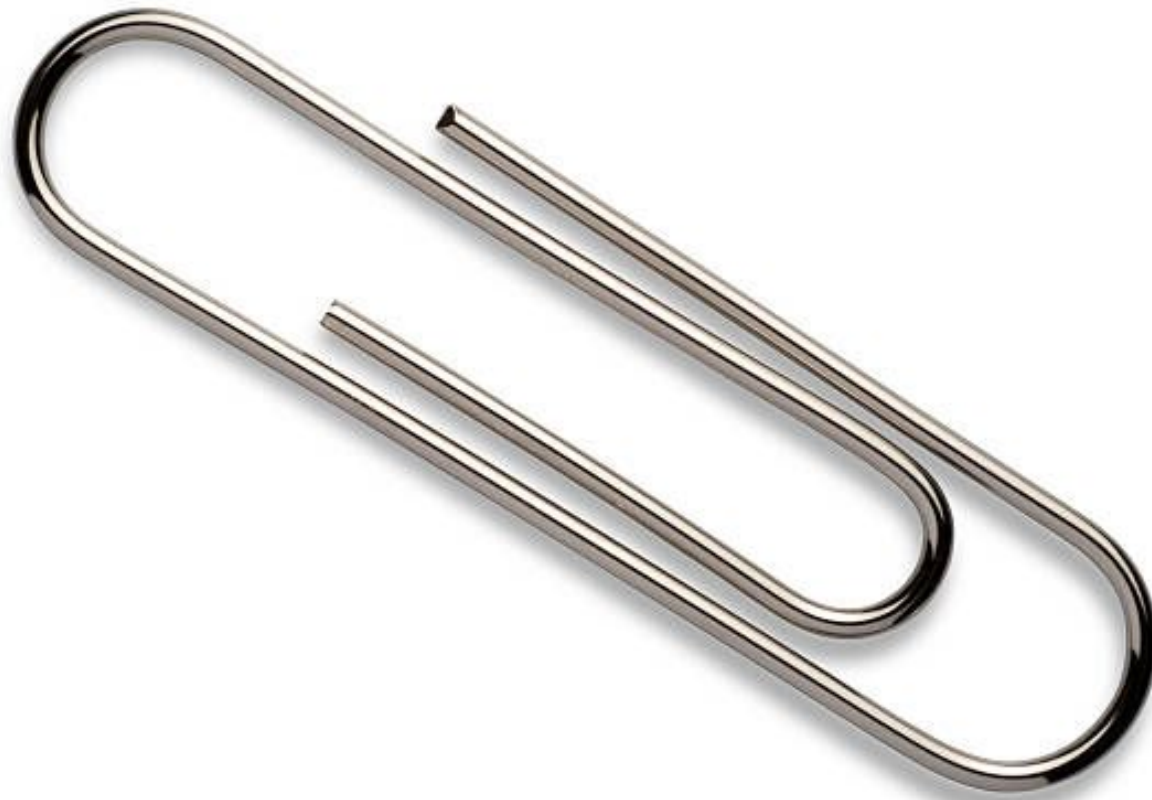



Group work session 1: Think of 100 uses for a paper clip...
(10min)



Welcome back! Now, how many uses have you come up with?



IDEATION - Introduction

Ideation...The formation of ideas & concepts



The more you exercise your creative muscle,
the easier it is to create solutions to problems

The best ideas...

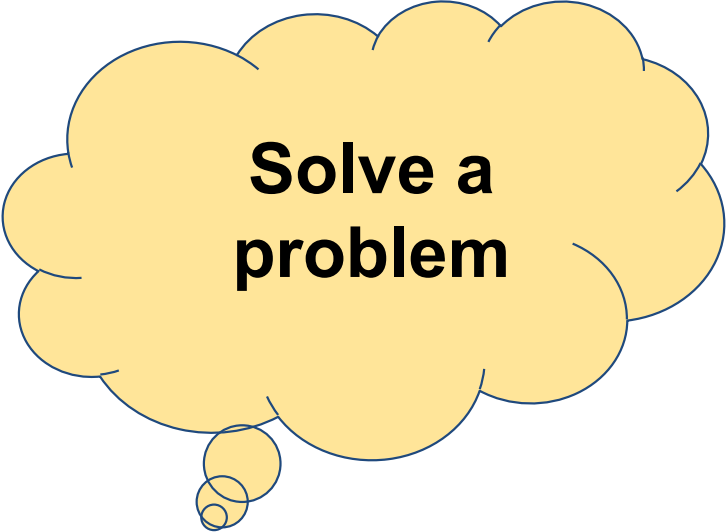

**Solve a
problem**



**Satisfy a
need**



**Create an
experience**



**Create a
habit**

Let's try some 'out of the box' thinking?



Game No 1: Mix & Match

What **2 or more**
products/items can be brought
together for the first time to
solve a problem for someone?

Game No 1: Mix & Match

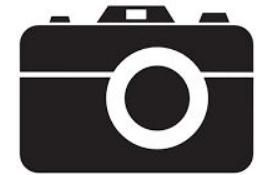
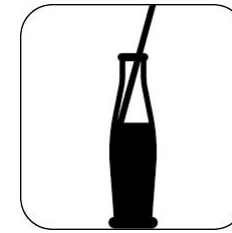
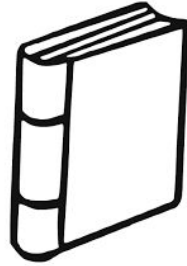

An illustration of a group of seven stylized human figures in a circle, each with a different colored body (yellow, pink, blue, green, red, purple, and light blue). Above each figure is a speech bubble of a different color (yellow, pink, blue, green, red, purple, and light blue). The figures are connected by a dark grey line at the bottom. A semi-transparent grey banner is overlaid across the middle of the image.

Group work session 2: Ideation game 'Mix & Match'
(10min)



Welcome back! Tell us about your 'mixing & matching'



Game No 1: Mix & Match - Examples



Game No 1: Mix & Match - Examples



Berliner
Splitterbrötchen



Muffin



Spluffin



Game No 1: Mix & Match - Examples



Game No 1: Mix & Match - Examples

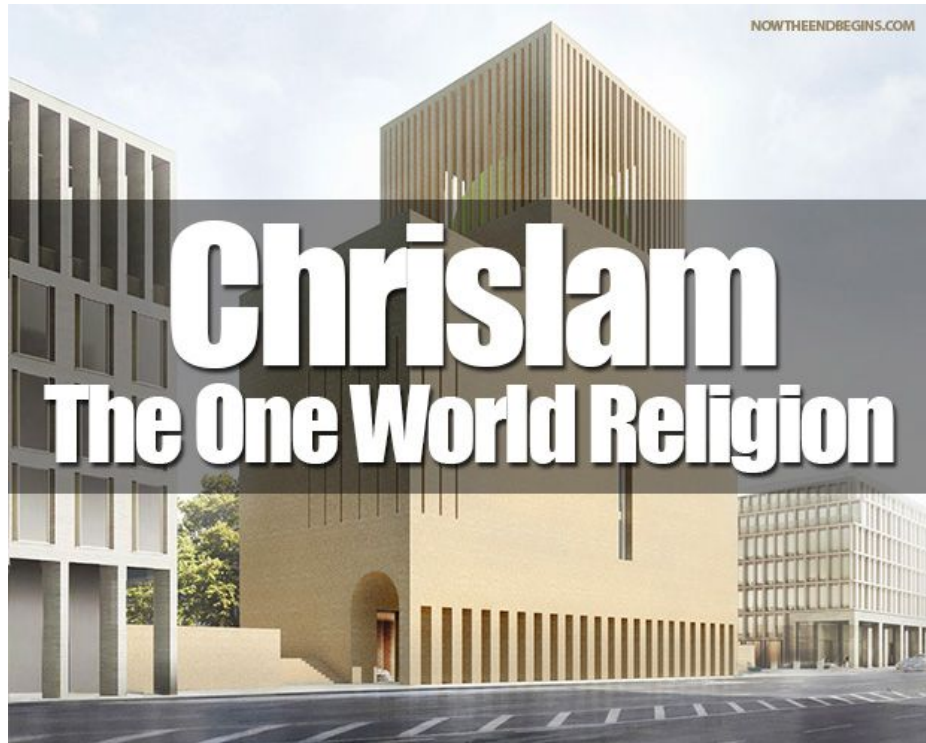

Game No 2: What bugs you?



Game No 2: What bugs you?

What **difficulties** do you encounter in daily life?

Always ask **is there a better way?**

Identify these problems and find solutions

- Morning routine?
- Commute?
- Work place?
- (Food) Shopping?
- Travelling?
- Getting your hair done?
- ...



An illustration of a group of seven stylized human figures in a circle, each with a different colored body (yellow, pink, blue, green, red, purple, and light blue). Above each figure is a speech bubble of a different color (yellow, pink, blue, green, red, purple, and light blue). The figures are connected by a dark grey line at the bottom. A semi-transparent grey rectangular box is overlaid on the center of the image, containing text.

Group work session 3: Ideation game 'What bugs you?'
(10 min)

Welcome back! Tell us about your problems & solutions!

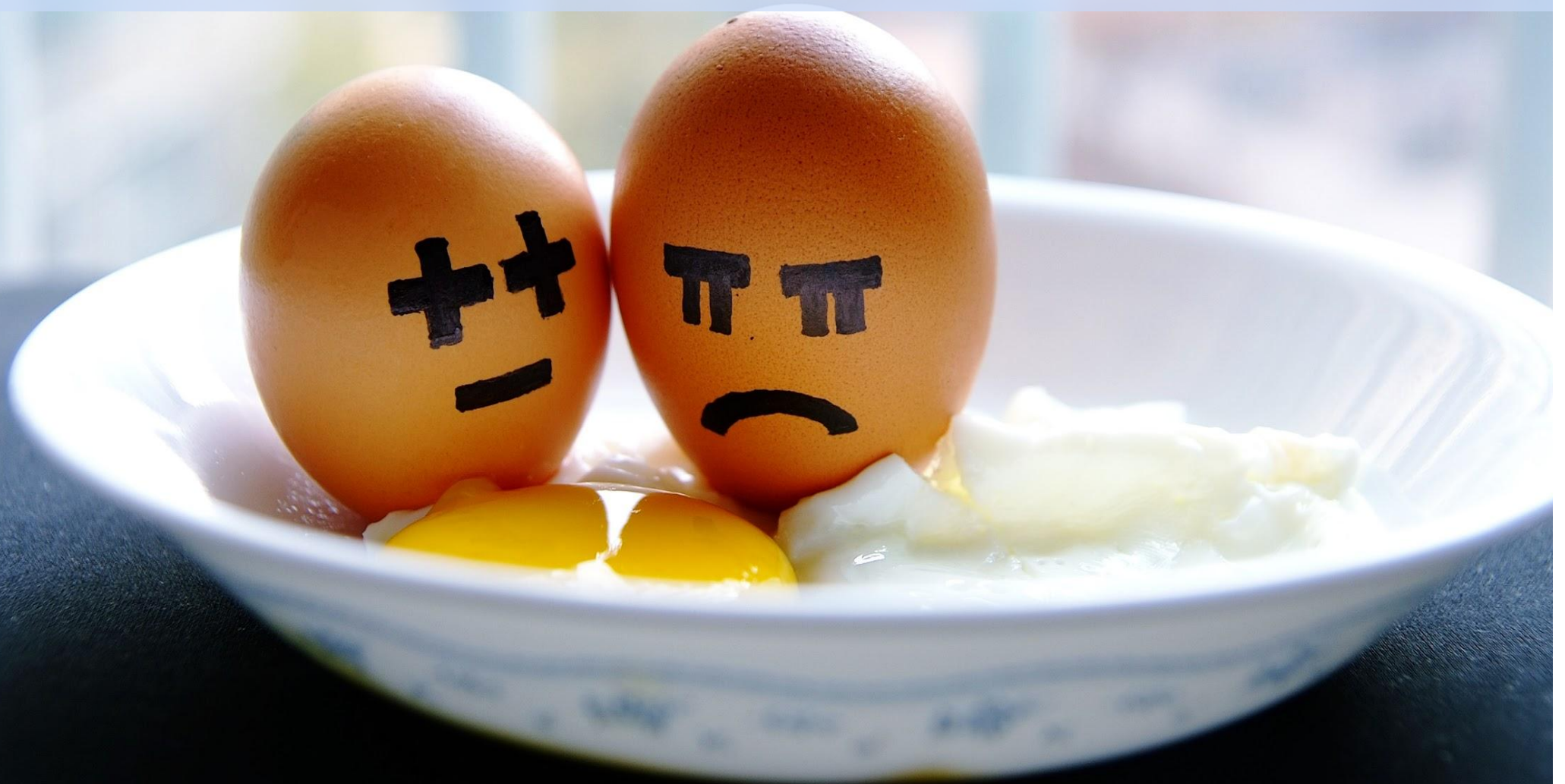

Game No 2: What bugs you? Examples



Game No 2: What bugs you?

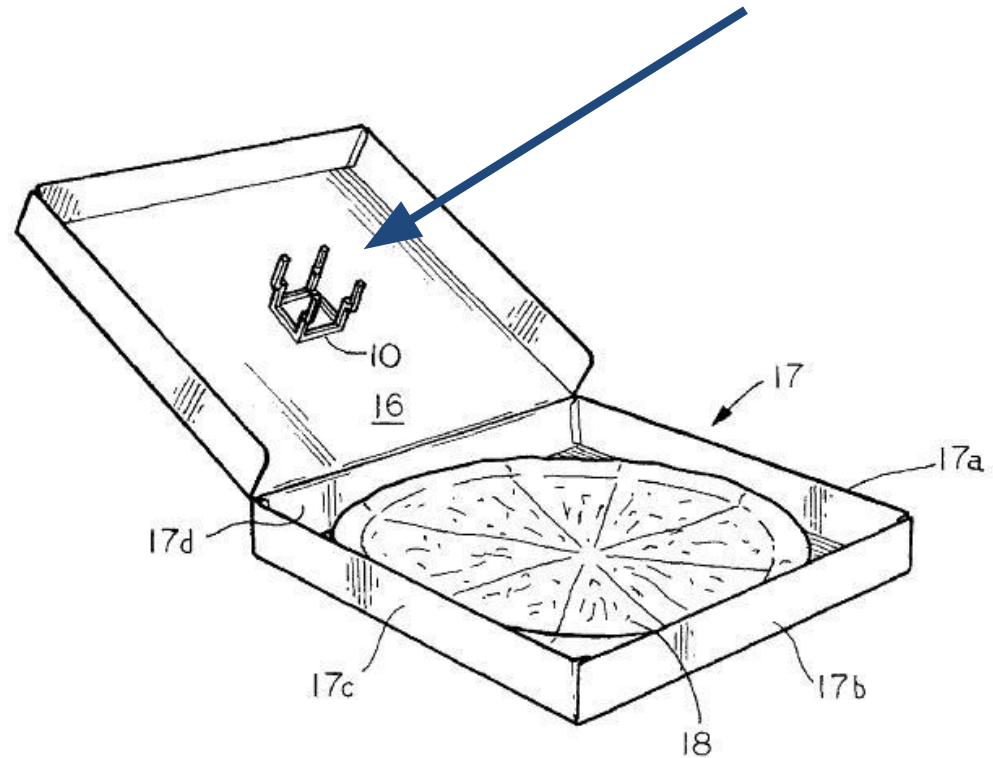

Game No 2: What bugs you?



IDEATION: Other methods...

Meet SCAMPER...

- **S**ubstitute
- **C**ombine
- **A**dapt
- **M**odify
- **P**ut to another use
- **E**liminate
- **R**everse

Some fun at the end...





End of session catch-up

Reflections? Thoughts?
Take homes?

Rules.

Garda Presence

slow response from Garda

THREATS

PERSONAL

GARDA Presence

Etiquette Environments
- sheet
- pub
- trays, bags etc

Legislation

LAW
Legal Awareness
works against

Drunks

Teedies
Jubbies

Jubbie Springs
= weapon

Jubbie/Spring

No Legal Responsibility

TA VES

Shop Security
Alarms.

night

Issues

street unhealthy environment

Closed. open.

also, city ducks visitors tourists young children

organized crime

OBSERVATION

positive

Personal Threat

Personal Awareness

Personal Security

Personal Safety

Personal Protection

Personal Preparedness

Your Top 3 take aways from this session



Please post them into the chat!

Some fun at the end...



A person is shown from the chest up, facing slightly to the left. Their face and upper body are covered in vibrant, multi-colored body paint in shades of red, orange, yellow, and blue. They wear a crown or headpiece made of small, colorful flowers. In their hands, they hold a glowing, translucent sphere that emits a bright white light, casting a soft glow on their face and hands. The background is dark and indistinct.

"The real voyage of
discovery consists not
in seeking new
landscapes, but in
having new eyes."
Marcel Proust



T'was great fun!
Thank you for your attention!